



CANOPIA[®]
by PALRAM

HOW TO ASSEMBLE

HEAVY DUTY SHELF KIT™

IMPORTANT!

Please read these instructions carefully before starting assembly.
Keep these instructions in a safe place for future reference.

www.canopia.com



A member of
Palram Industries Ltd.

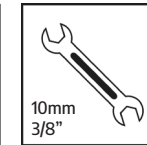
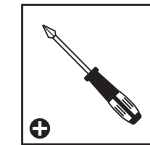
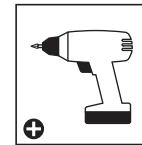
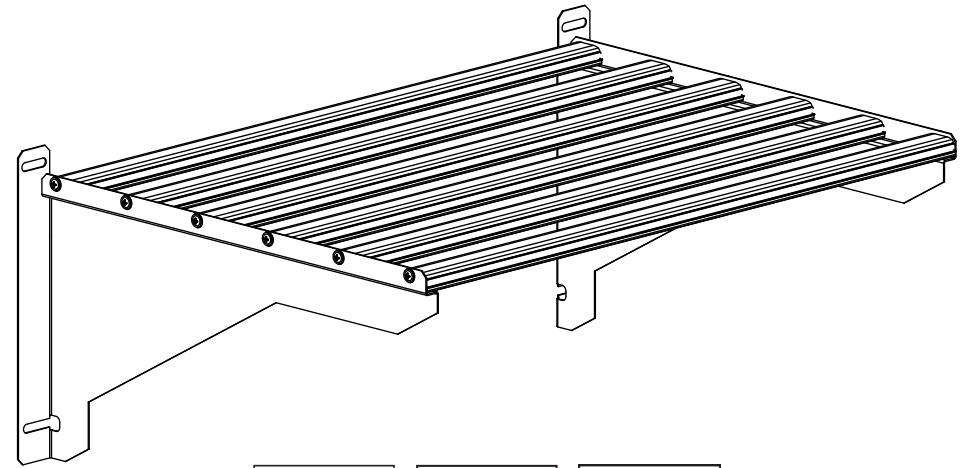



1

PARTS REQUEST

In the case of missing or damaged parts, do not return product to store.

Go to the link below or scan the QR code for help, it will direct you to a form that will help us assist you as soon as possible.



SCAN ME

Contact us on our website:
bit.ly/3js7yZi

2

ASSEMBLY ASSISTANCE

If you need any technical assistance in assembling your product, go to the link below or scan the QR code for help. It will direct you to a form that will help us assist you as soon as possible.



SCAN ME

Contact us on our website:
bit.ly/3kqqFEc



CUSTOMER SUPPORT



SCAN ME

WE ARE HERE TO HELP

For general questions: bit.ly/3kY07dP

USA

 877-627-8476

 hobbyservice@poly-tex.com

CANADA

 905-5646007

 sales@footprintproducts.com

UNITED KINGDOM · IRELAND

 01302-380775

 customer.serviceUK@palram.com

GERMANY

 0180-522-8778

 customer.serviceDE@palram.com

FRANCE · BELGIUM

 +33-169-791-094

 customer.serviceFR@palram.com

ISRAEL

 04-848-6816

 info.il@palram.co.il

ITALY · NETHERLANDS · PORTUGAL · SPAIN

 +33-169-791-094

 customer.serviceFR@palram.com

AUSTRIA · LUXEMBURG · LIECHTENSTEIN

 +49-180-522-8778

 customer.serviceDE@palram.com

AUSTRALIA

 03-9219-4444

 salesvic@palram.com

NORWAY · SWEDEN · ARGENTINA · GREECE · GREENLAND · ICELAND · ESTONIA · JAPAN · LATVIA · LITHUANIA
MAURITIUS · MEXICO · ROMANIA · RUSSIA · TURKEY · UZBEKISTAN · UKRAINE · SWAZILAND · KOREA

 +972-4-848-6816

 customer.service@palram.com



CUSTOMER SUPPORT



SCAN ME

WE ARE HERE TO HELP

For general questions: bit.ly/3kY07dP

AUSTRALIA - GREENHOUSES

 03-9544-6-999

 info@mazedistribution.com.au

HUNGARY · SLOVAKIA

 +420-493-523-523

 servis@garland.cz

NEW ZEALAND

 0800 800 880

 customer.service@palram.com

DENMARK

 07-575 42 70

 post@nshnordic.com

SOUTH AFRICA

 011-397-7771

 receptionza@palram.com

CROATIA · SLOVENIA

 0599-37-057

 info@ms-viscom.com

CZECH REPUBLIC

 0493-523-523

 servis@garland.cz

FINLAND

 Neuvonta: 09-6866720
Tuki / Varaosat: 050-3715350

 www.horizontenterprises.fi
tuki@horizontenterprises.fi

POLAND

 Infolinia: 801-011-929
22-349-93-36

 kontakt@ogrodosfera.pl

CYPRUS

 0224-971-13

 alpaco@alpacodomica.com
www.alpacodomica.com

SWITZERLAND

 062-287-33-77

 info@ritter.ch